



for a greener tomorrow



**MITSUBISHI  
ELECTRIC**

*Changes for the Better*

FACTORY AUTOMATION

MELSEC iQ-F Series  
iQ Platform-compatible PLC

FX5UJ-24M□/□, FX5UJ-40M□/□,  
FX5UJ-60M□/□

**MELSEC iQ-F**  
series



*New* **FX5UJ**

Start any control from here

# FX5UJ

## Enhanced performance and ease of use for any machine

FX5UJ, which excels in cost performance, is equipped with various built-in functions which earned popularity in FX5U(C), and promotes increased ease of use.



FX5UJ-24MR/ES AC D2 R  
 FX5UJ-24MT/ES AC D2 T1  
 FX5UJ-24MT/ESS AC D2 T2

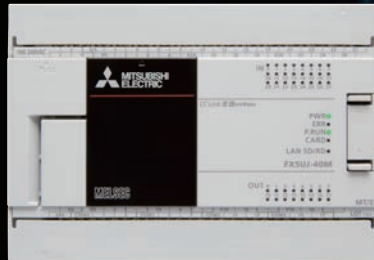

FX5UJ-40MR/ES AC D2 R  
 FX5UJ-40MT/ES AC D2 T1  
 FX5UJ-40MT/ESS AC D2 T2



FX5UJ-60MR/ES AC D2 R  
 FX5UJ-60MT/ES AC D2 T1  
 FX5UJ-60MT/ESS AC D2 T2

AC AC power supply D2 DC input (sink/source) R Relay output T1 Transistor output (sink) T2 Transistor output (source)

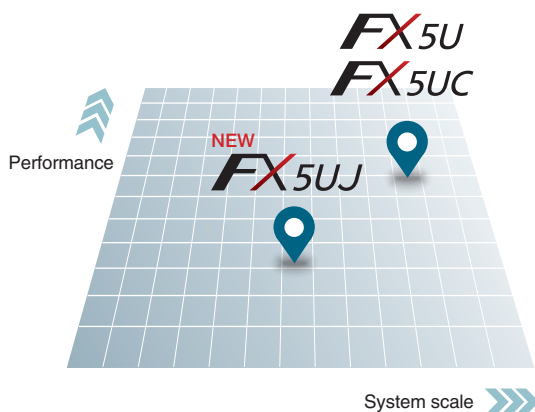

## New CPU modules added to the MELSEC iQ-F series lineup

### Highly functional models



FX5U/FX5UC

- Up to 512 points of control
- FX5U CPU module: 32/64/80 points
- FX5UC CPU module: 32/64/96 points



FX5UJ **NEW**

- Up to 256 points of control
- CPU module: 24/40/60 points

## Basic specifications of the FX5UJ, which offers excellent performance at a reasonable price and can support a wide range of applications

Program capacity  
**48 k steps**

Separate areas are used for data such as comments and labels, ensuring sufficient memory capacity.

Control scale  
**256 points**

(1) No. of input/output points 256 points or less  
 (2) No. of remote I/O points 256 points or less  
 Total No. of points of (1) and (2) 256 points or less

Instruction execution speed  
 (LD, MOV instruction)  
**34 ns**

The speed has been increased to approximately twice that of the FX3U.

Up to two communication adapters can be connected.\*1

Up to 2 analog adapters can be connected.

Standard equipment

- SD memory card slot
- Built-in USB (Mini-B) connector
- Built-in Ethernet port (up to 8 connections)

Up to 8 I/O modules/intelligent function modules can be connected.\*2



\*1: The maximum number of devices is 1 when an expansion board is connected to the CPU module.  
\*2: The number of devices is limited by the intelligent function modules.

## Enhanced built-in functions

### Built-in positioning function

- Supports positioning of up to 3 axes
- Output pulse trains of 200 kpps (transistor output)



### Built-in high-speed counter function

The CPU module has 8 channels of built-in high-performance high-speed counters. This enables match output and range output control that do not depend on the scan time.



## Enhanced built-in ports

### SD memory card slot

Standard-equipped with an SD memory card slot, which is essential for functions such as logging and backup/restore.

### USB (Mini-B) connector

Another interface for programming, in addition to the Ethernet port! The standard equipped USB (Mini-B) connector makes it easier to connect to engineering tools.

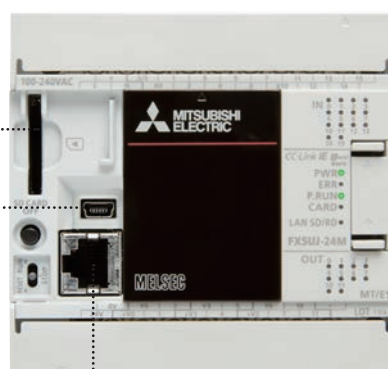

### Ethernet port

The Ethernet port enables communication through **up to 8 connections** on the network.

CC-Link IE field network Basic is also supported.

This lets you construct a network with general-purpose Ethernet.

# Take the first step toward switching to IoT with FX5UJ built-in functions

[FX5UJ support]

GX Works3: Ver. 1.060N or later, GX LogViewer and logging setting tool: Ver. 1.100E or later

## Sharing information between manufacturing lines

### Simple CPU communication function

Using a simple parameter setting with GX Works3, device data such as production data can be transferred without any program.

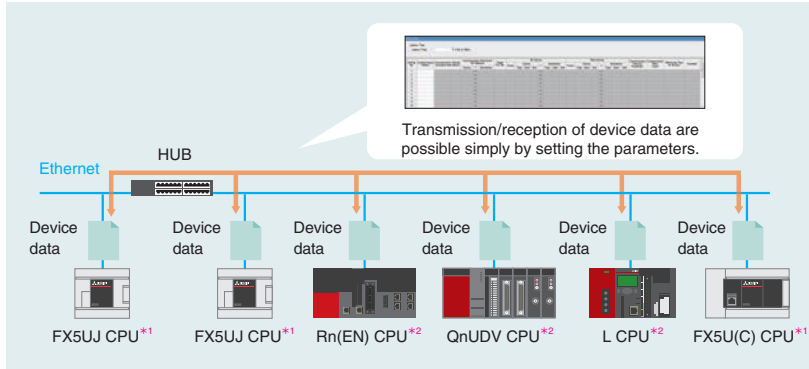

\*1: Built-in Ethernet function \*2: Requires connecting device configuration.

Sharing information between manufacturing lines

Access from remote offices

## Access from remote offices

### FTP server function

With the FTP server function, logging data can be acquired from a remote location without going to the site. Multiple logging files can be managed collectively from the office computer, reducing management and maintenance work.

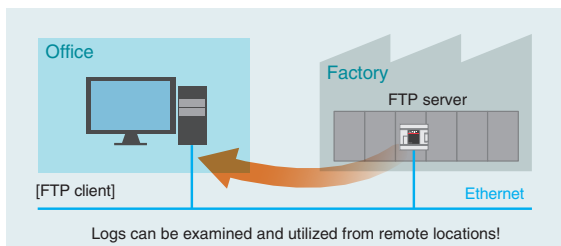

## Access from remote offices

### Web server function

Accessing the Web server from a Web browser on a PC enables CPU module monitoring and diagnosis without any dedicated tools.

The operating status of equipment at factories can be viewed from remote offices or when away from the site.

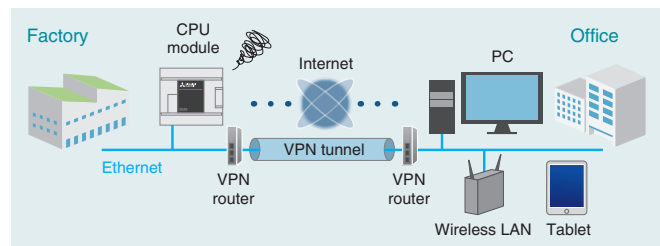

**Troubleshooting**

**Data logging function**

Information can be saved to the SD memory card periodically from the computer and network equipment. Using the saved data enables efficient analysis of device operating status and trouble causes. Furthermore, by using the offline monitor function with the data logging function, the logged device data can be monitored and displayed in the program editor. This is useful for debugging when problems occur.

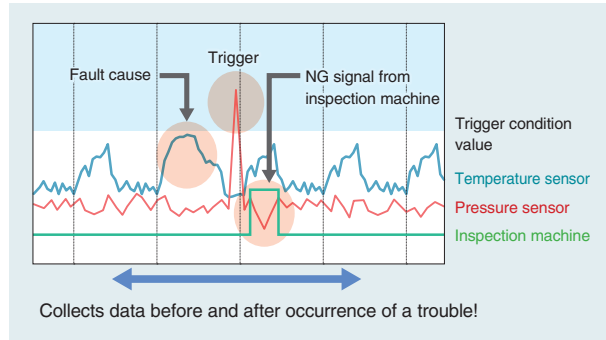
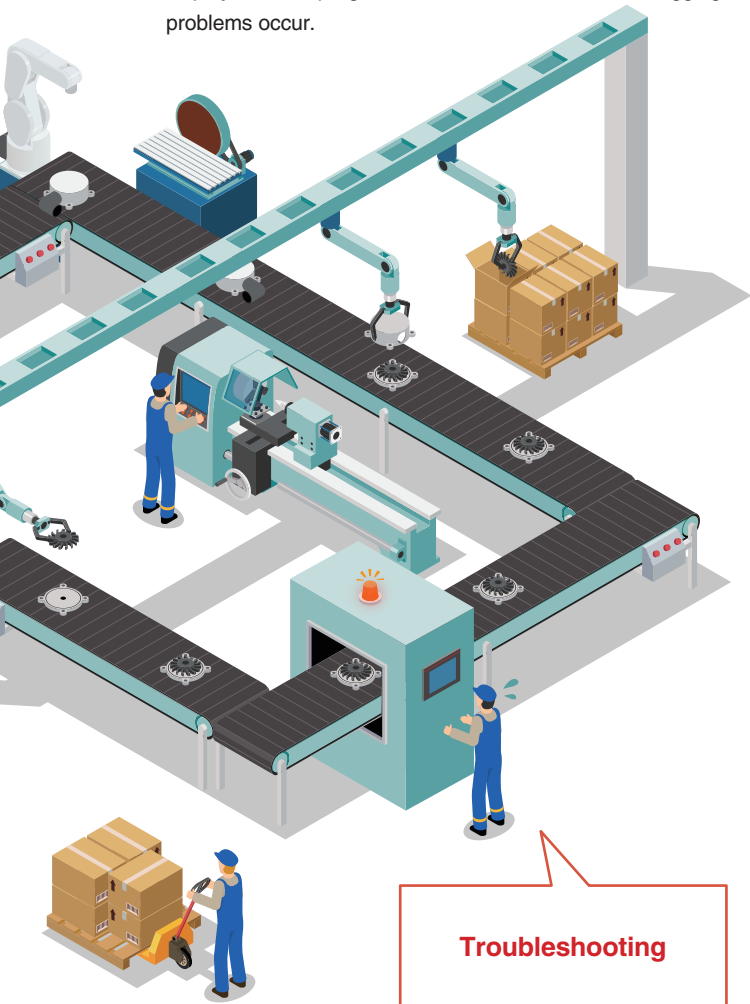

**Troubleshooting**

**Memory dump function**

The CPU module device value can be saved in the SD memory card at an arbitrary timing. By setting the trigger to be established when an error occurs, the status at error occurrence can be confirmed. This is helpful in investigating and pinpointing the cause.

The collection results can be confirmed with GX Works3.

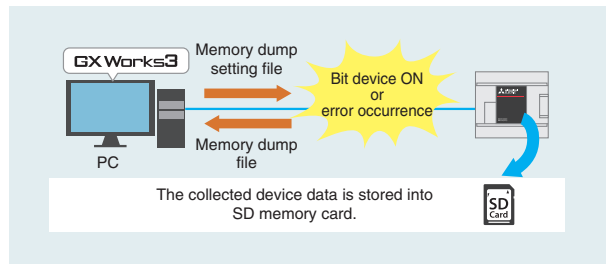

**Troubleshooting**

**Real-time monitoring function**

The contents of any devices can be monitored on real-time basis using GX LogViewer. The debugging efficiency is considerably improved at startup and troubleshooting. This function facilitates the resetting procedure, and enables graph check at a later time.

**Troubleshooting**

**Backup/restore functions**

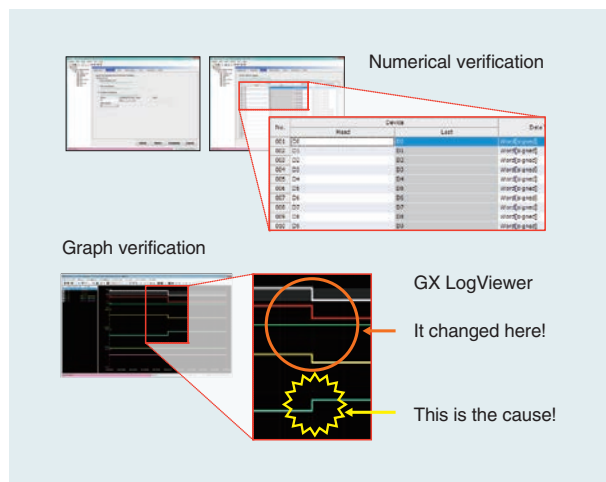
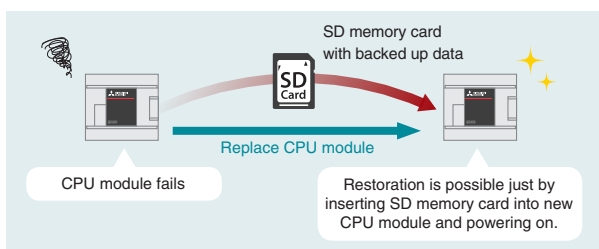

The device/label data and data memory in the CPU module can be backed up to the SD memory card. Backed-up data can be restored as needed.



Some operation restrictions apply to each function. For details, refer to the manual.

## Diverse FX5UJ functions

The FX5UJ is equipped with the same diverse range of built-in functions as the FX5U(C). This provides excellent performance at a reasonable cost and helps you switch to IoT.

Item			MELSEC iQ-F Series		
			 FX5UJ	 FX5U	
Number of control points	Total No. of points of (1) and (2)		256 points or less	512 points or less	
	(1) No. of input/output points		256 points or less	384 points or less	
	(2) No. of remote I/O points		256 points or less	512 points or less	
Operation speed			LD: 0.034 μs	LD: 0.034 μs	
			MOV: 0.034 μs	MOV: 0.034 μs	
Program capacity			48 k step	128 k step <sup>*1</sup>	
Built-in functions <sup>*1</sup>	General-purpose communication ports	Ethernet	✓	✓	
		USB (Mini-B)	✓ (MELSOFT connection)	—	
		RS-485	—	✓	
	Analog		—	Analog input × 2 ch, analog output × 1 ch	
	Positioning (Transistor output)		200 kpps × 3 axes	200 kpps × 4 axes	
	High-speed counter (1-phase 1-input)		100 kHz × 4 ch	200 kHz × 8 ch	
			10 kHz × 4 ch	(FX5U-32M only: 200 kHz × 6 ch + 10 kHz × 2 ch)	
	SD memory card slot		✓	✓	
	Maintenance functions	Data logging	✓	✓	
		Memory dump	✓	✓	
		Real-time monitoring	✓	✓	
		Backup/restore, Boot operation	✓	✓	
	Network (Ethernet)	CC-Link IE Field Network Basic	✓ (8 stations)	✓ (16 stations)	
		Simple CPU communication	✓ (8 stations)	✓ (16 stations)	
		Others	MELSOFT connection, SLMP (3E frame), Socket communication, Predefined protocol support, MODBUS/TCP communication, Time setting function (SNTP client)		
	Other networks		N:N network, parallel link, MC protocol, Inverter communication, Non-protocol communication, predefined protocol support, CC-Link, MODBUS/RTU communication, MELSOFT connection etc.		
	Firmware update		✓	✓	
	Ethernet related functions	FTP server function		✓	✓
		Web server function	System Web page	✓	✓
			User Web page	—	✓
Clock function	Display data		Year, month, day, hour, minute, second, day of week (leap year automatic detection)	Year, month, day, hour, minute, second, day of week (leap year automatic detection)	
	Precision		Differences per month ±45 sec./25°C (TYP)	Differences per month ±45 sec./25°C (TYP)	
Power failure retention (clock data)	Retention method		Large-capacity capacitor	Large-capacity capacitor	
	Retention time		15 days (Ambient temperature: 25°C)	10 days (Ambient temperature: 25°C) <sup>*2</sup>	
Expandability <sup>*3</sup>	Simple motion module		Up to 1 module	Up to 16 modules	
	Intelligent function module		Up to 8 modules	Up to 16 modules	
	Communication adapter		Up to 2 modules <sup>*4</sup>	Up to 2 modules	
	Analog adapter		Up to 2 modules	Up to 4 modules	
	Expansion board		Up to 1 module	Up to 1 module	

✓: Supported —: Not supported

<sup>\*1</sup>: For the FX5U, there are restrictions on the versions that support each function. For details, refer to the manual.

<sup>\*2</sup>: This can be maintained with the optional battery.

<sup>\*3</sup>: For the intelligent function modules and the expansion adapters, the same types of products as with the FX5U(C) can be used.

There are restrictions on the number of extension modules that can be connected to a single CPU module system. For details, refer to the manual.

<sup>\*4</sup>: The maximum number of communication adapters that can be connected is one when an expansion board is connected to the CPU module.

## Easy programming with GX Works3

[FX5UJ support] GX Works3: Ver. 1.060N or later

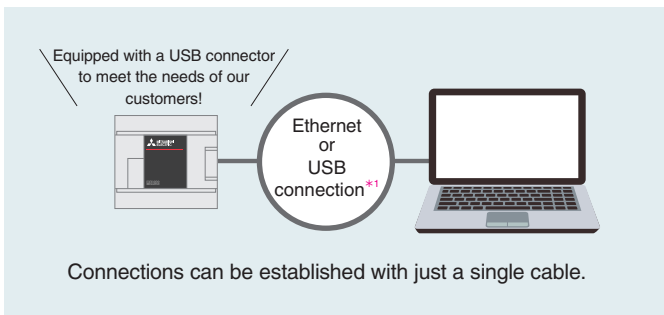

GX Works3 is the next generation of our engineering software. It is simple and easy to use while still supporting structured programming and offering a diverse suite of new functions and technologies designed for MELSEC iQ-R series and iQ-F series control systems. This one piece of software can be used to intuitively perform operations ranging from system design to maintenance, reducing development costs.

## An introduction to GX Works3 functions

### System design with a convenient parts library

With GX Works3, designing a system is as easy as preparing the module configuration diagram by dragging and dropping selected parts.

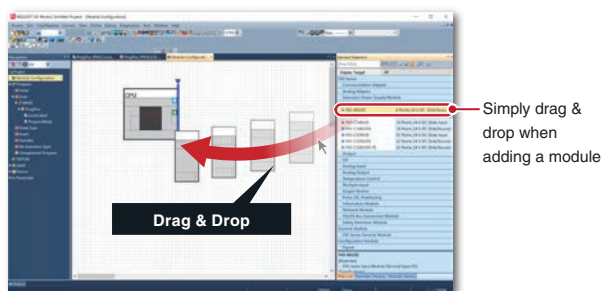

### Auto-generation of module parameters

When preparing the module configuration diagram, simply double-click the module to automatically generate the module parameters.

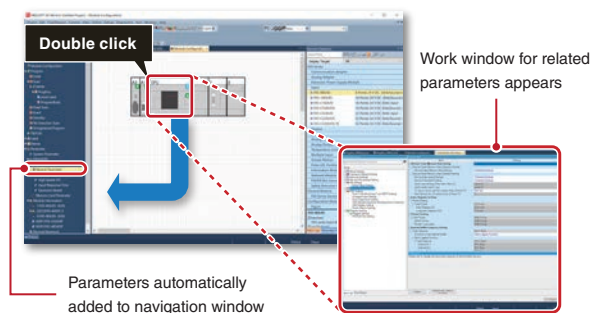

### Main programming languages supported

The main IEC languages are supported by GX Works3. Various different programming languages can be used within the same project simultaneously and can be viewed easily via the menu tab.

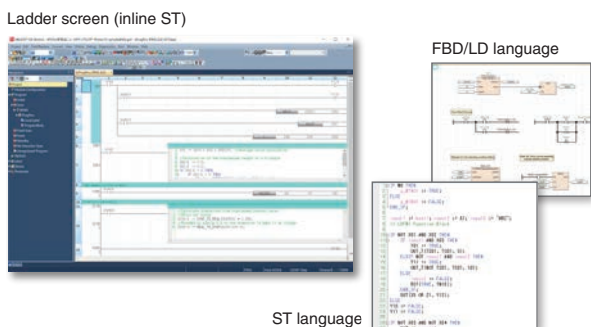

### Automatically start diagnoses just by establishing a USB connection

Just establish a USB connection between the PC and the CPU module to make GX Works3 automatically start a diagnosis. The module where the error occurred, error information, and corrective actions will all be displayed.

This lets you quickly check information and procedures required for troubleshooting.

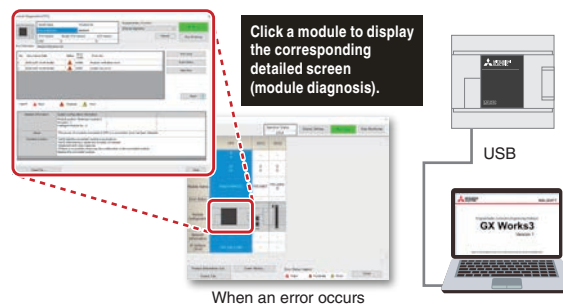

\*1: The driver is installed automatically when the PC and CPU module are connected. If the driver is not installed automatically, install it manually. For details, refer to the MELSEC iQ-F FX5 User's Manual (Application).

# PROGRAMMABLE CONTROLLERS

## MELSEC iQ-F Series

### ■ Generic specifications (For details, refer to the manual.)

Item	Specifications
Operating ambient temperature	0 to 55°C, non-freezing
Storage ambient temperature	-25 to 75°C, non-freezing
Operating ambient humidity	5 to 95%RH, non-condensation
Storage ambient humidity	5 to 95%RH, non-condensation

### ■ Power supply specifications

Item	Specifications	
Rated voltage	100 to 240 V AC	
Voltage fluctuation range	-15%, +10%	
Frequency rating	50/60 Hz	
Allowable instantaneous power failure time	Operation can be continued upon occurrence of instantaneous power failure for 10 ms or less. When the supply voltage is 200 V AC or higher, the time can be change to 10 to 100 ms by editing the user program.	
Power fuse	250 V, 3.15 A Time-lag fuse	
Rush current	FX5UJ-24M□	25 A max. 5 ms or less/100 V AC 50 A max. 5 ms or less/200 V AC
	FX5UJ-40M□, FX5UJ-60M□	30 A max. 5 ms or less/100 V AC 50 A max. 5 ms or less/200 V AC
Power consumption*1	FX5UJ-24M□	30 W
	FX5UJ-40M□	32 W
	FX5UJ-60M□	35 W
24 V DC service power supply capacity*2	FX5UJ-24M□	400 mA*3, 460 mA*4
	FX5UJ-40M□	400 mA*3, 500 mA*4
	FX5UJ-60M□	400 mA*3, 550 mA*4

- \*1: This item shows value when all 24 V DC service power supplies are used in the maximum configuration connectable to the CPU module. (The current of the input circuit is included.)  
 \*2: When I/O modules are connected, they consume current from the 24 V DC service power supply.  
 \*3: Supply capacity when 24 V DC service power supply is used for input circuit of the CPU module.  
 \*4: Supply capacity when external power supply is used for input circuit of the CPU module.

### ■ 24 V DC input (sink/source)

(For the input circuit configuration, refer to the manual.)

Item	Specifications		
No. of input points	FX5UJ-24M□: 14 points, FX5UJ-40M□: 24 points, FX5UJ-60M□: 36 points		
Connection type	Removable terminal block (M3 screws)		
Input type	Sink/source		
Input signal voltage	24 V DC +20%, -15%		
Input signal current	[X0 to X7] 5.3 mA/24 V DC [X10 and subsequent] 4.0 mA/24 V DC		
Input impedance	[X0 to X7] 4.3 kΩ [X10 and subsequent] 5.6 kΩ		
ON input sensitivity current	[X0 to X7] 3.5 mA or more [X10 and subsequent] 3.0 mA or more		
OFF input sensitivity current	1.5 mA or less		
Input response frequency	X0, X1, X3, X4 (When capturing pulses of a response frequency of 50 to 100 kHz, refer to the manual.)	100 kHz	
	X2, X5, X6, X7	10 kHz	
Pulse waveform	Waveform		
		T1 (pulse width)	T2 (rise/fall time)
		X0, X1, X3, X4 X2, X5, X6, X7	5 μs or more 50 μs or more
Input response time (H/W filter delay)	X0, X1, X3, X4 X2, X5, X6, X7	ON: 5 μs or less OFF: 5 μs or less	
	X10 to X17	ON: 30 μs or less OFF: 50 μs or less	
	X20 and subsequent	ON: 50 μs or less OFF: 150 μs or less	
Input response time (Digital filter setting value)	X0 to X17	None, 10 μs, 50 μs, 0.1 ms, 0.2 ms, 0.4 ms, 0.6 ms, 1 ms, 5 ms, 10 ms (initial values), 20 ms, 70 ms When using this product in an environment with much noise, set the digital filter.	
Input signal format (Input sensor form)	No-voltage contact input Sink: NPN open collector transistor Source: PNP open collector transistor		
Input circuit insulation	Photo-coupler insulation		
Indication of input operation	LED is lit when input is ON		

### ▲ Safety Warning

To ensure proper use of the products in this document, please be sure to read the instruction manual prior to use.

### ■ Relay output (For the output circuit configuration, refer to the manual.)

Item	Specifications
No. of output points	FX5UJ-24MR/ES: 10 points, FX5UJ-40MR/ES: 16 points, FX5UJ-60MR/ES: 24 points
Connection type	Removable terminal block (M3 screws)
Output type	Relay
External power supply	30 V DC or less 240 V AC or less ("250 V AC or less" if not a CE, UL, cUL compliant item)
Max. load	2 A/point The total load current per common terminal should be the following value. • 3 output points/common terminal: 6 A or less*5 • 4 output points/common terminal: 8 A or less*5
Min. load	5 V DC, 2 mA (reference values)
Open circuit leakage current	—
Response time	OFF→ON: Approx. 10 ms ON→OFF: Approx. 10 ms
Output circuit insulation	Mechanical insulation
Indication of output operation	LED is lit when output is ON

### ■ Transistor output (For the output circuit configuration, refer to the manual.)

Item	Specifications
No. of output points	FX5UJ-24MT/□: 10 points, FX5UJ-40MT/□: 16 points, FX5UJ-60MT/□: 24 points
Connection type	Removable terminal block (M3 screws)
Output type	FX5UJ-□MT/ES: Transistor/sink output FX5UJ-□MT/ESS: Transistor/source output
External power supply	5-30 V DC
Max. load	0.5 A/point The total load current per common terminal should be the following value. • 3 output points/common terminal: 0.6 A or less*5 • 4 output points/common terminal: 0.8 A or less*5
Open circuit leakage current	0.1 mA or less/30 V DC
Voltage drop when ON	[Y0 to Y2] 1.0 V or less [Y3 and subsequent] 1.5 V or less
Response time	[Y0 to Y2] 2.5 μs or less/10 mA or more (5-24 V DC) [Y3 and subsequent] 0.2 ms or less/200 mA or more (24 V DC)
Output circuit insulation	Photo-coupler insulation
Indication of output operation	LED is lit when output is ON

\*5: For details on the common, refer to the manual.

### ■ External dimensions

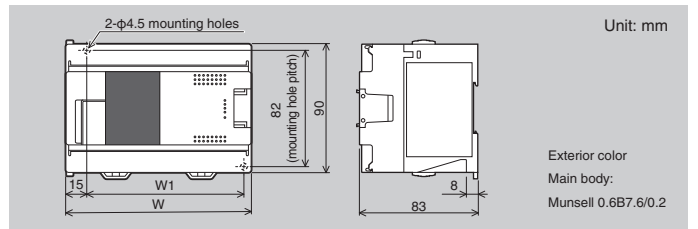

Item	W	W1 (mounting hole pitch)	Mass (weight)
FX5UJ-24M□	95 mm	76 mm	Approx. 0.55 kg
FX5UJ-40M□	130 mm	111 mm	Approx. 0.65 kg
FX5UJ-60M□	175 mm	156 mm	Approx. 0.80 kg

### ■ Product list

Item	Rated voltage	Input specifications		Output specifications			
		No. of input points	Input type	No. of output points	Output type		
FX5UJ-24MR/ES	100 V AC to 240 V AC	14	24 V DC sink/source	10	Relay		
FX5UJ-24MT/ES					Transistor/sink		
FX5UJ-24MT/ESS					Transistor/source		
FX5UJ-40MR/ES					16	Relay	
FX5UJ-40MT/ES						Transistor/sink	
FX5UJ-40MT/ESS						Transistor/source	
FX5UJ-60MR/ES		24		Relay			
FX5UJ-60MT/ES				Transistor/sink			
FX5UJ-60MT/ESS				Transistor/source			
FX5UJ-U-HW-E				MELSEC iQ-F FX5UJ User's Manual (Hardware)			
FX5-U-OU-E				MELSEC iQ-F FX5 User's Manual (Application)			
MR-J3USBCBL3M [3 m]				USB cables for connecting a PC			
GT09-C30USB-5P [3 m]							

### Registration

- Ethernet is a registered trademark of Fuji Xerox Co., Ltd. in Japan.
- The SD and SDHC logos are trademarks of SD-3C, LLC.
- The company names, system names and product names mentioned in this document are either registered trademarks or trademarks of their respective companies.
- In some cases, trademark symbols such as "™" or "®" are not specified in this document.

## MITSUBISHI ELECTRIC CORPORATION

HEAD OFFICE: TOKYO BLDG., 2-7-3, MARUNOUCHI, CHIYODA-KU, TOKYO 100-8310, JAPAN  
<http://Global.MitsubishiElectric.com>